

KA-550D

SERVICE MANUAL

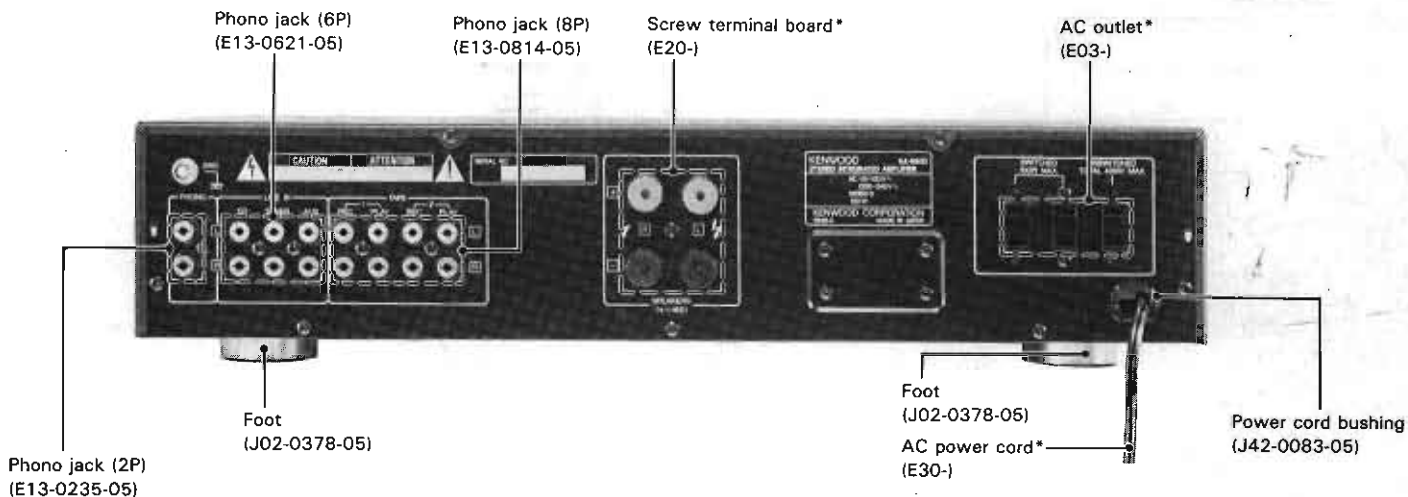
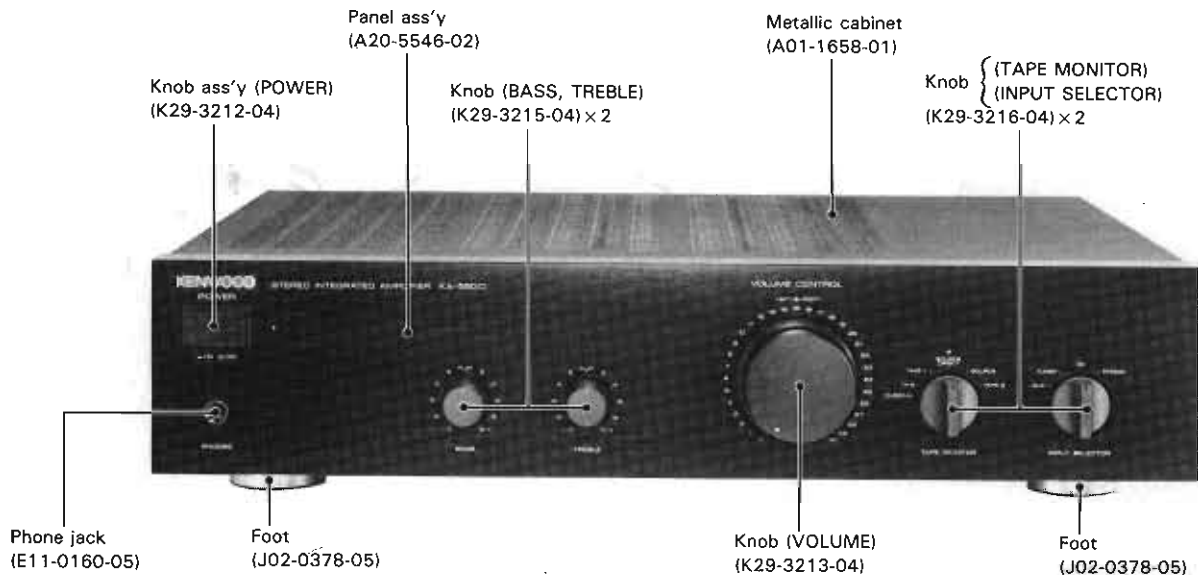

* Refer to parts list on page 18.

CONTENTS

BLOCK & LEVEL DIAGRAM	2	CIRCUIT DIAGRAM	13
CIRCUIT DESCRIPTION	3	EXPLODED VIEW	17
ADJUSTMENT/REGLAGES/ABGLEICH	4	PARTS LIST	18
PC BOARD (Components side view)	5	SPECIFICATIONS	Back cover
PC BOARD (Foil side view)	9		

BLOCK & LEVEL DIAGRAM

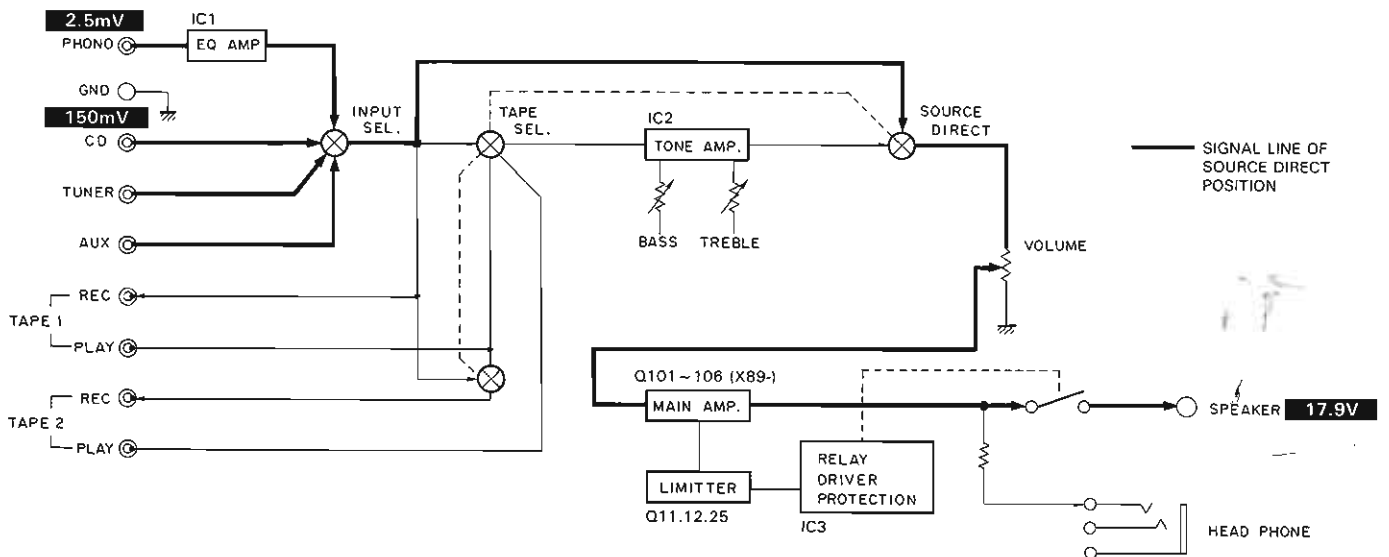

CIRCUIT DESCRIPTION

DESCRIPTION OF COMPONENTS

Audio unit (X09-3642-71)

Component	Use/Function	Operation/Condition/Compatibility
Q11, 12	Protection	Current limiter Tr. Used to limit the current flowing to the final Tr in case of an overload drive.
Q21, 22	AVR for EQ power supply	
Q23, 24	PHONO shock noise prevention	
Q25	Protection	Transmits the operation signals of current limiter Q11 and Q12 to the protection IC (IC3).
IC1 (M5218P-A)	EQ circuit operation amp	
IC2 (M5218P-A)	Tone circuit operation amp	
IC3 (μ PC1237HA)	Protection IC	
D1, 2	Current limiter	1SS131 or 1SS178
D11, 12	Static electricity protection	1SS133 or 1SS176
D13, 14	Constant current for the EQ power supply	E-452
D15, 16	Constant voltage for the EQ power supply	RD16ES (B2) or HZS16N (B2)
D17	Constant voltage for the Class A power supply	RD15JS (B) or HZS15S (B)
D18	Protection	1SS131 or 1SS178
D19	LED power supply	DSM1A1 or S5566B
D20	Power rectifier diode	RBV-602LFA or D5SBA20F03
D21	Headphone shock noise prevention	DSM1A1 or S5566B
D22, 23	Constant-voltage tone circuit power supply	RD16ES (B2) or HZS16N (B2)
D24	Relay	1SS131 or 1SS178
D26, 27	Indicator LEDs	D26: For SOURCE DIRECT D27: For POWER

ADJUSTMENT/REGLAGES/ABGLEICH

ADJUSTMENT

No.	ITEM	INPUT SETTINGS	OUTPUT SETTINGS	AMPLIFIER SETTING	ALIGNMENT POINTS	ALIGN FOR	FIG.
Unless otherwise specified, the individual switches should be set as follows. POWER: ON SPEAKER: B REC OUT: OFF SELECTOR: PHONO							
1	IDLE CURRENT	-	Connect a DC voltmeter across CP1 (L) CP2 (R) (X09-)	VOLUME: 0	VR1 (L) VR2 (R) (X89-) (X07-)	9mV	(a)

REGLAGE

N°	ITEM	REGLAGE DE L'ENTREE	REGLAGE DE LA SORTIE	REGLAGE DE L'AMPLIFICATEUR	POINTS DE L'ALIGNMENT	ALIGNER POUR	FIG.
Sauf en cas d'indications spéciales, régler chaque commutateur comme suit. POWER: ON SPEAKER: B REC OUT: OFF SELECTOR: PHONO							
1	COURANT DE POLARISATION	-	Connecter un voltmètre de CC SUR CP1 (G) CP2 (D) (X09-)	VOLUME: 0	VR1 (G) VR2 (D) (X89-) (X07-)	9mV	(a)

ABGLEICH

NR.	GENGENSTAND	EINGANGS-EINSTELLUNG	AUSANG-EINSTELLUNG	VORSTÄRKER-EINSTELLUNG	ABGLEICHE-PUNKTE	ABGLEICHEN FÜR	ABB.
Außer wenn anders angegeben, die verschiedenen Schalter wie folgt einstellen. POWER: ON SPEAKER: B REC OUT: OFF SELECTOR: PHONO							
1	LEERLAUFSTROM	-	Einen Gleichspannungsmesser über CP1 (L) CP2 (R) anschießen. (X09-)	VOLUME: 0	VR1 (L) VR2 (R) (X89-) (X07-)	9mV	(a)

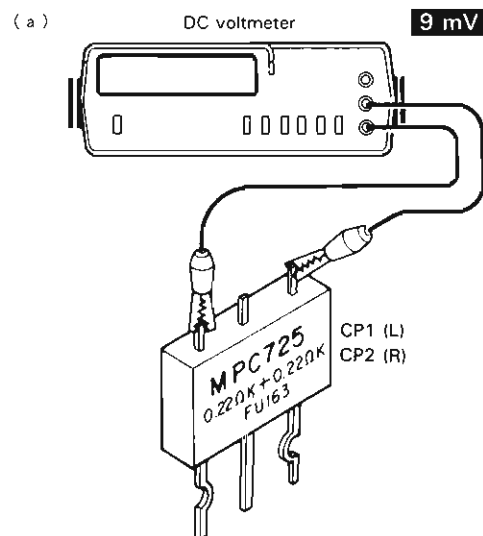

PC BOARD (Component side view)

AC 220V 50Hz

POWER SUPPLY UNIT (X00-2390-53)

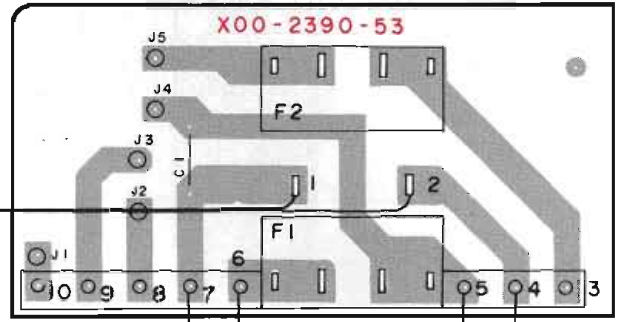

WHT
BRN

(E TYPE)

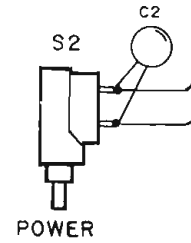

P.T.

BRN/W
RED/W
ORG/W

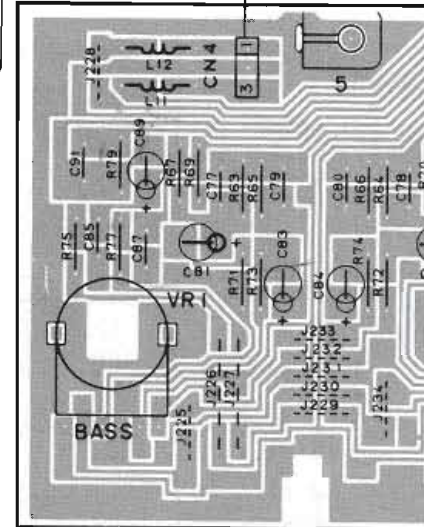
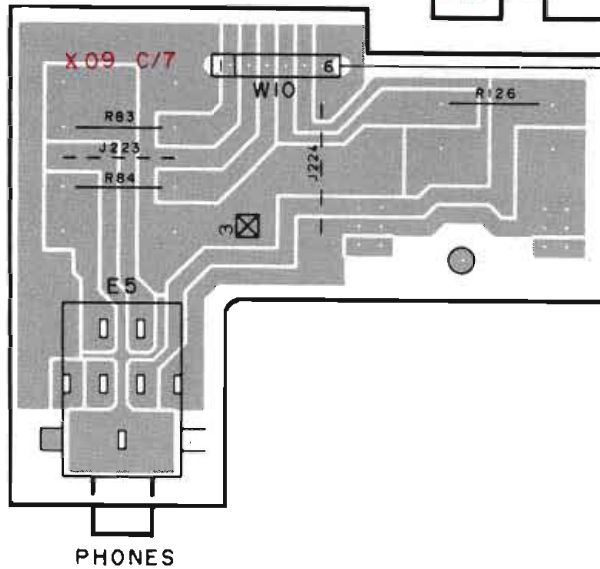
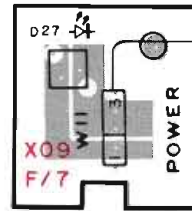

AUDIO UNIT (X09-3642-71)

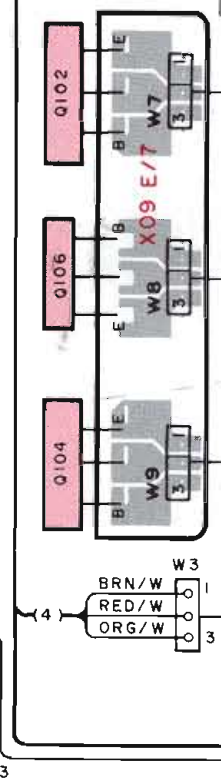
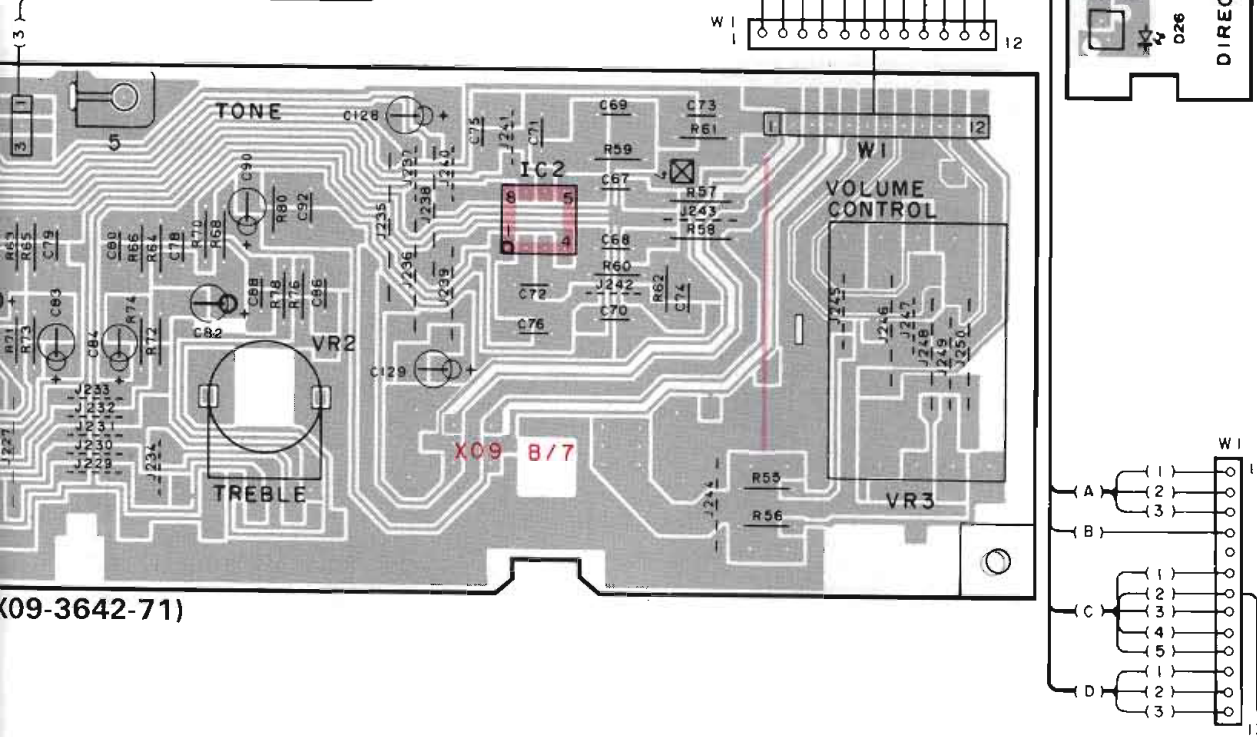
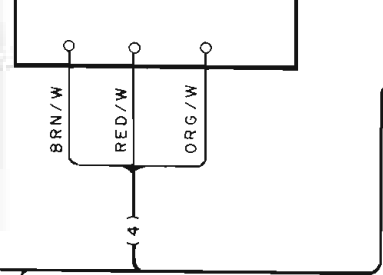
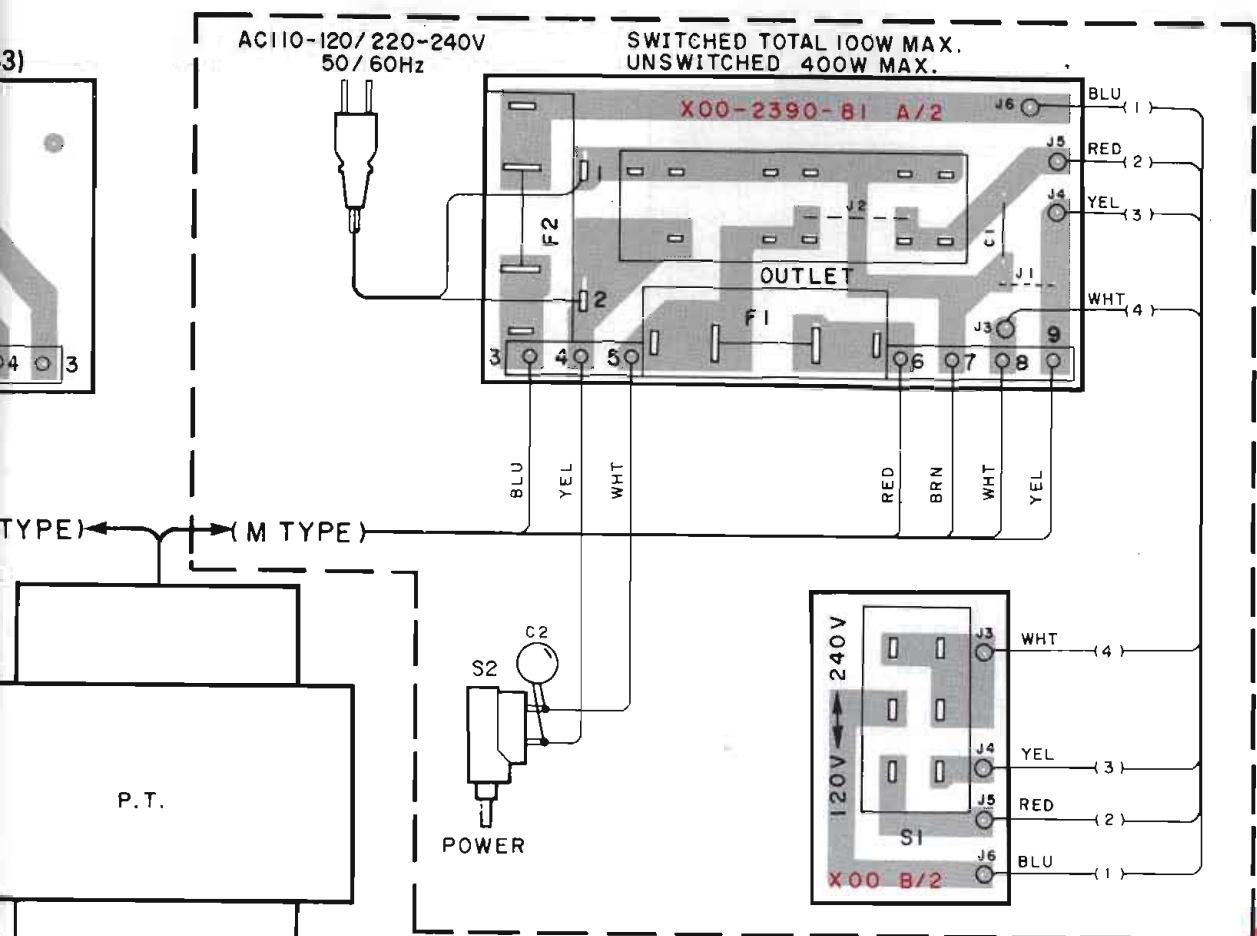

(X09-3642-71)

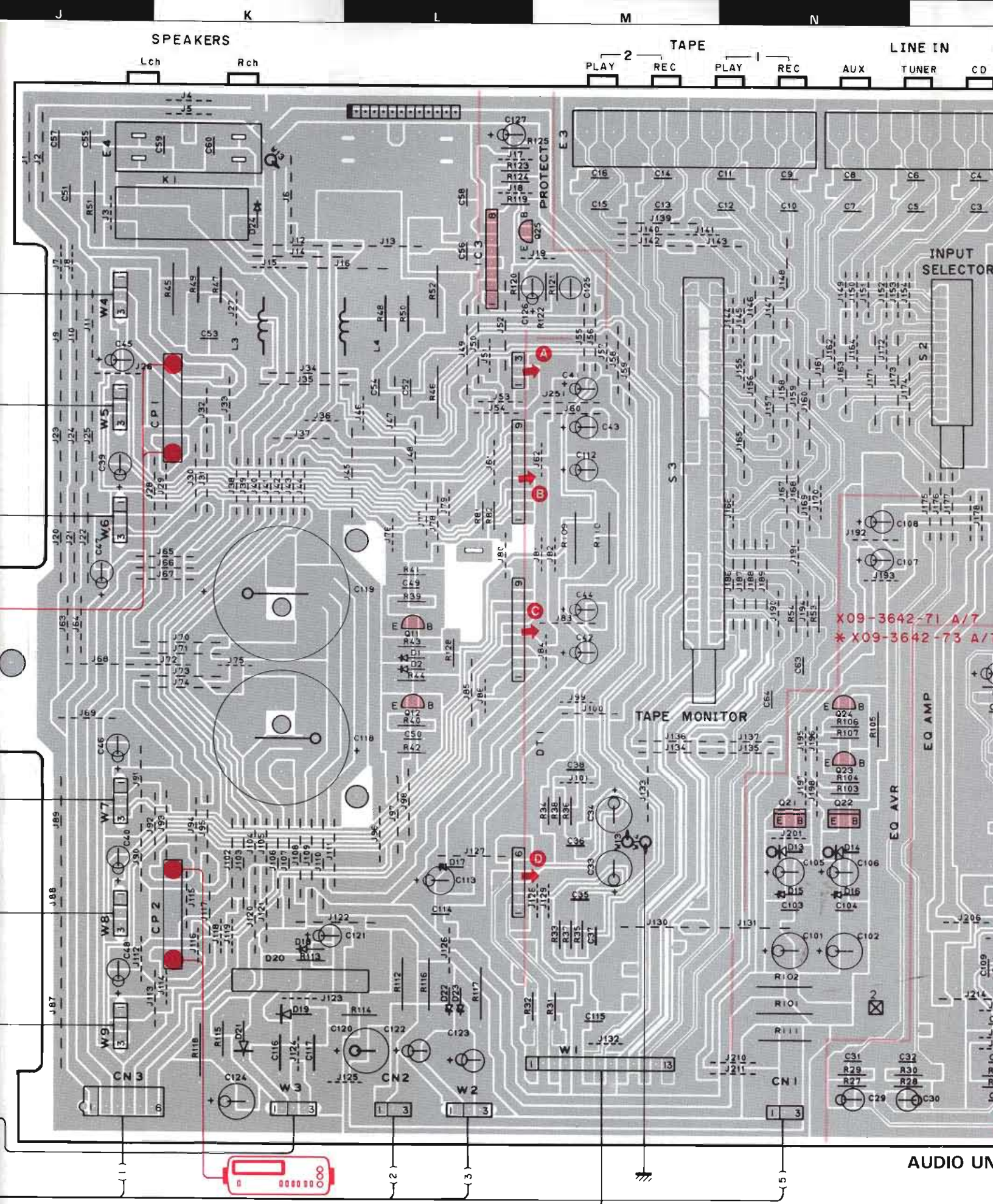

(a) DC voltmeter
IDLE CURRENT **9mV**

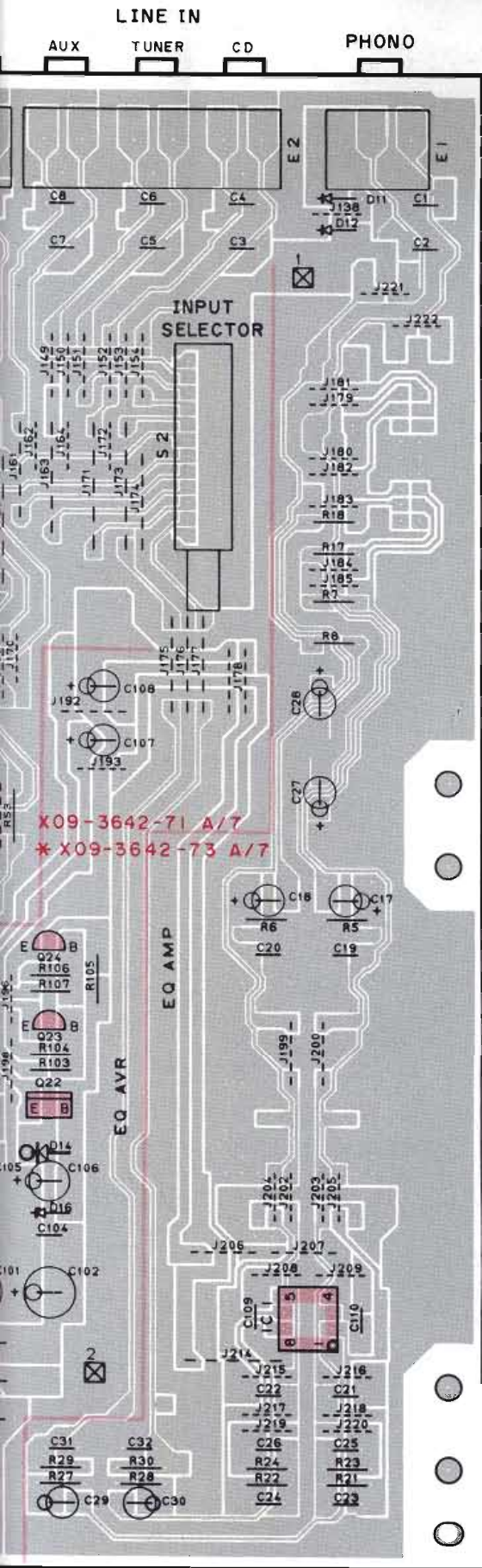

X09-3642-71 A/7
 * X09-3642-73 A/7

AUDIO UNIT (X09-3642-71)

X89-1010-06
 * X07-2362-74

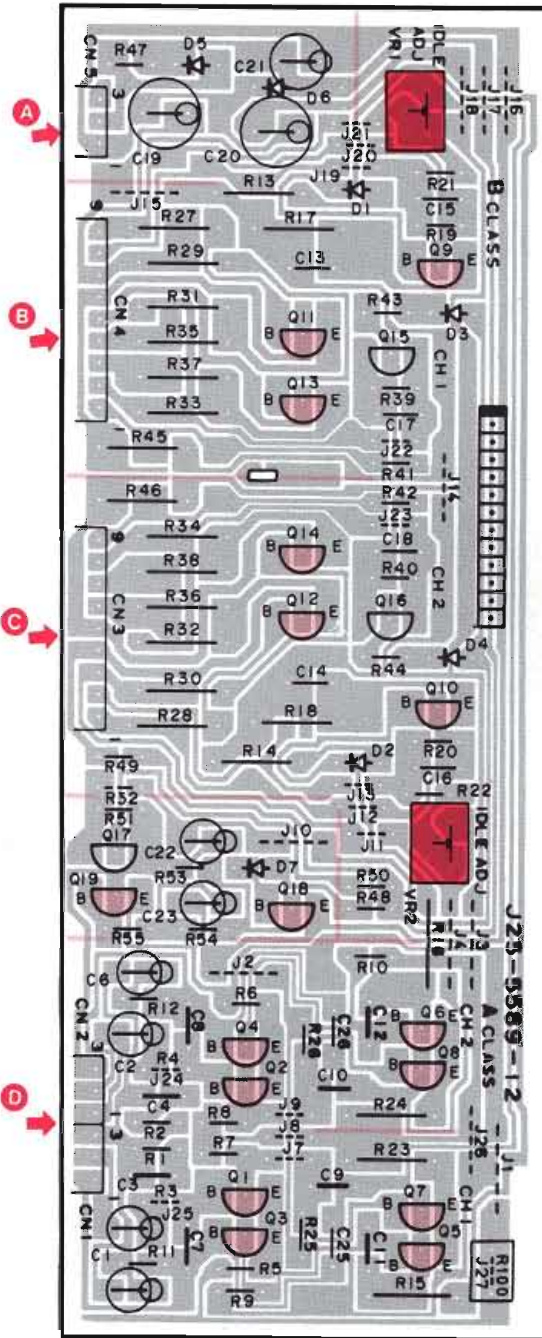

MAIN AMPLIFIER UNIT (X89-1010-06)

* SINGAPORE MADE



KA-550D (E)

Refer to the schematic diagram for the values of resistors and capacitors.

PC BOARD (Foil side view)

MAIN AMPLIFIER UNIT (X89-1010-06)
 X89-1010-06
 * X07-2362-74

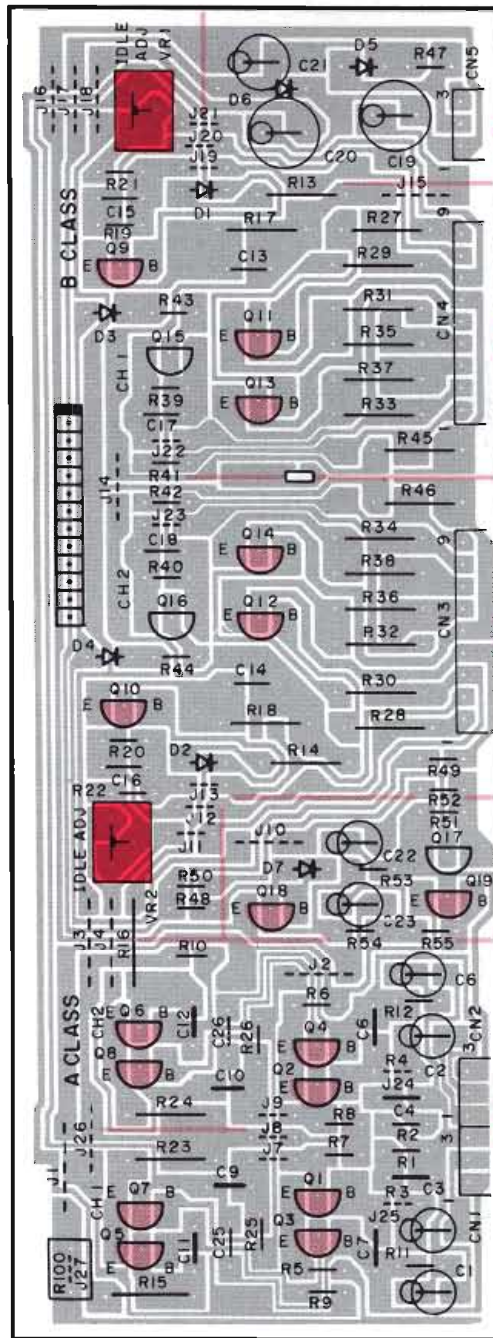

*SINGAPORE MADE

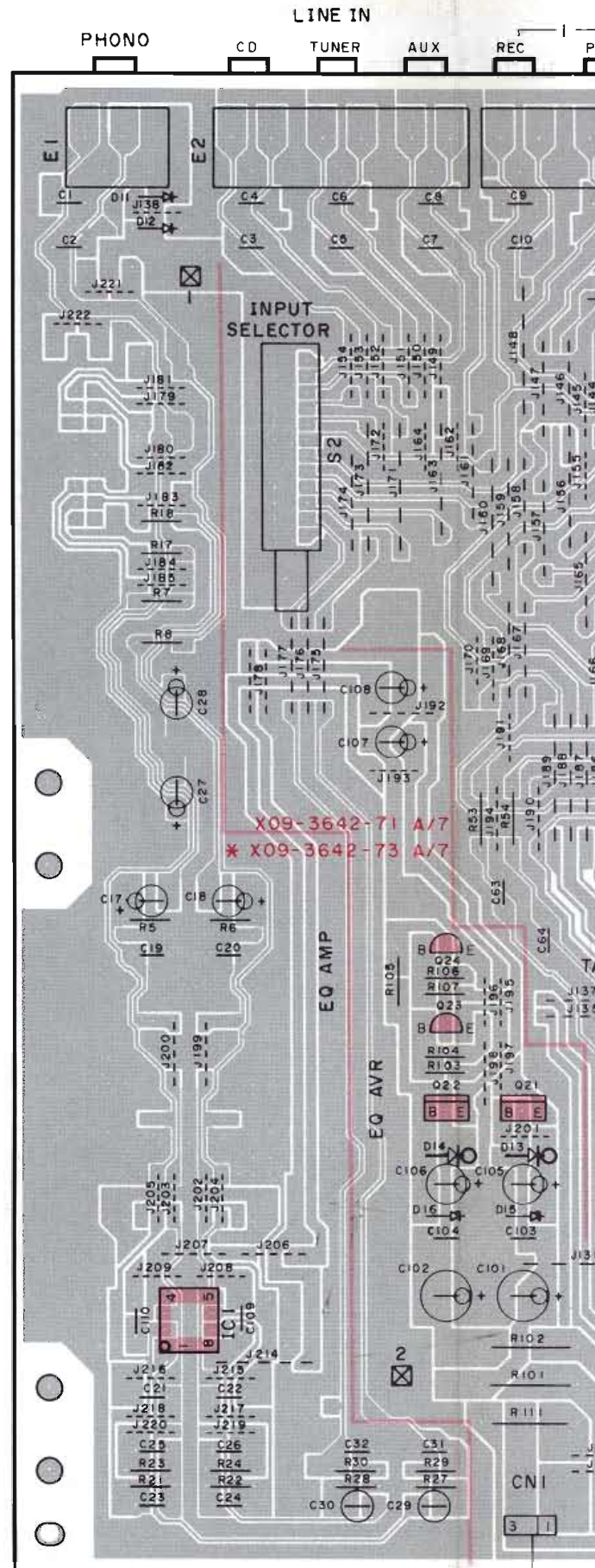

AUDIO UNIT (X09-3642-71)

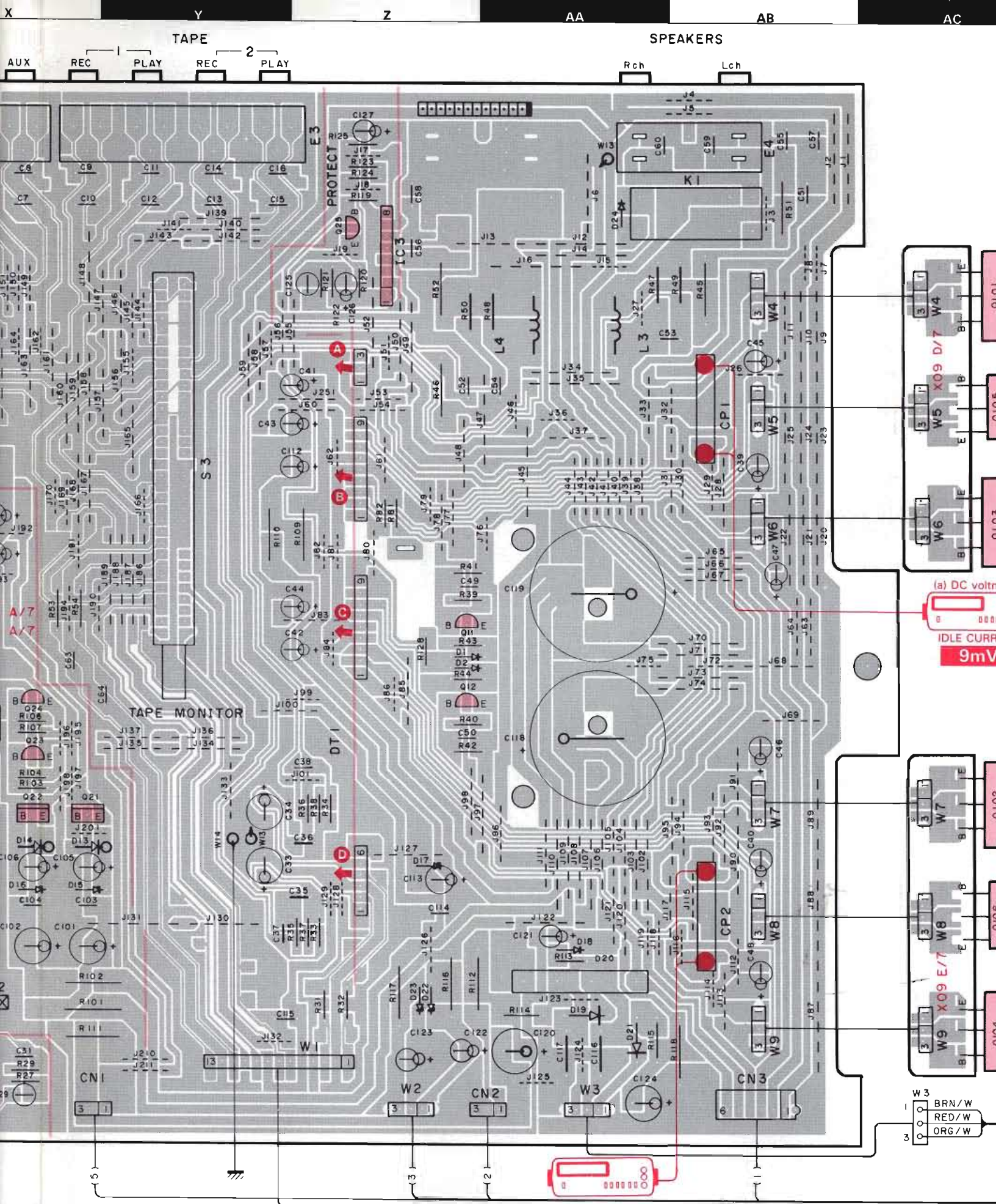

(a) DC voltmeter
 0 000
 IDLE CURR
 9mV

(a) DC voltmeter
 IDLE CURRENT 9mV

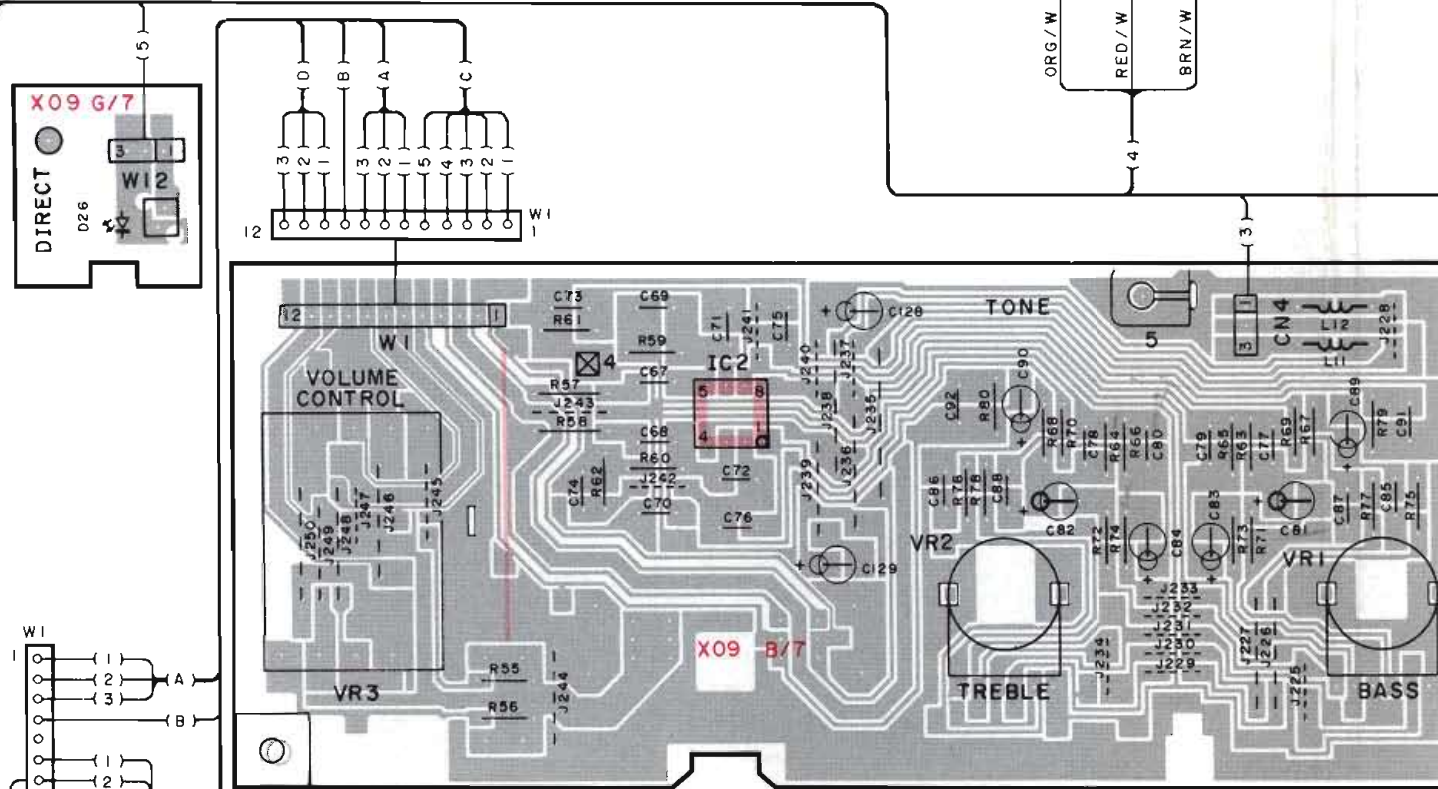
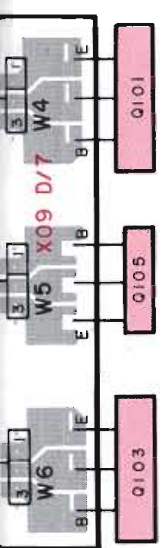
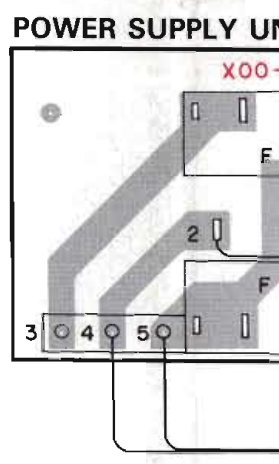
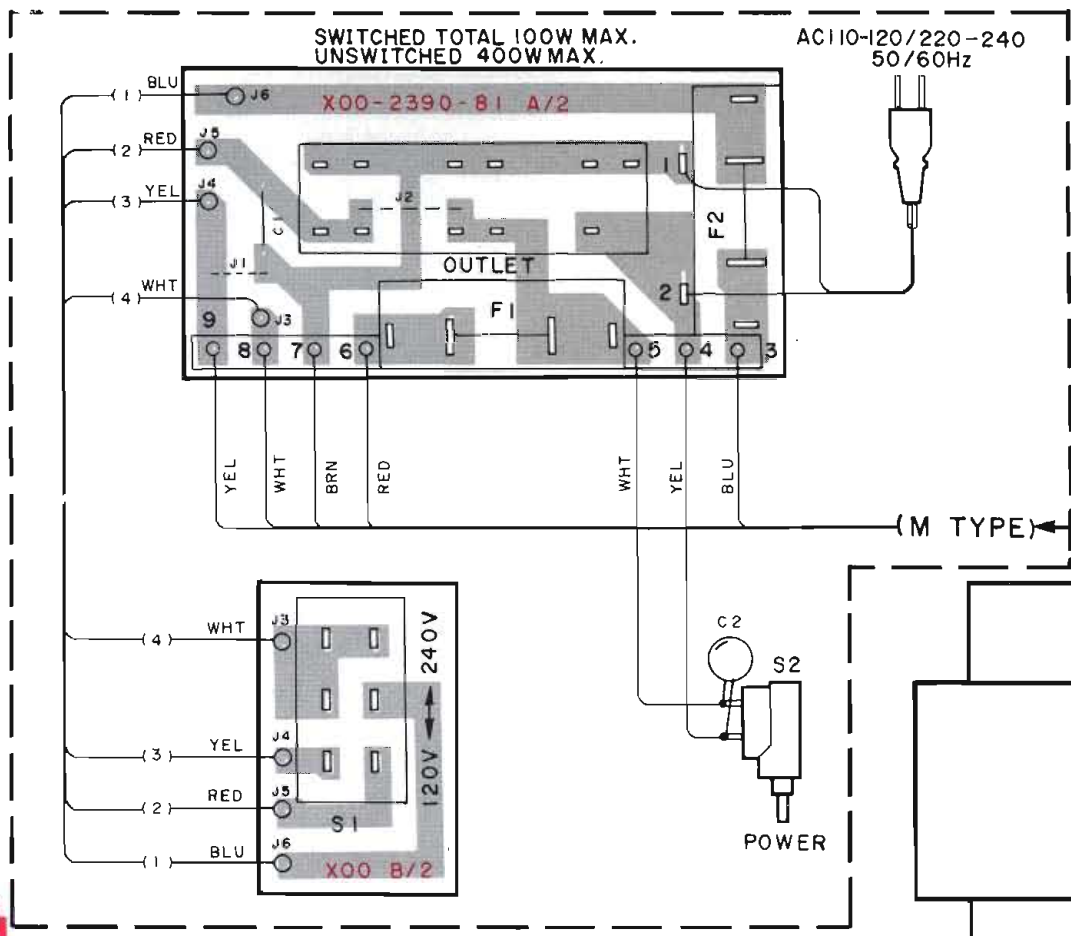

AUDIO UNIT (X09-3642-7)

POWER SUPPLY UNIT (X00-2390-53)

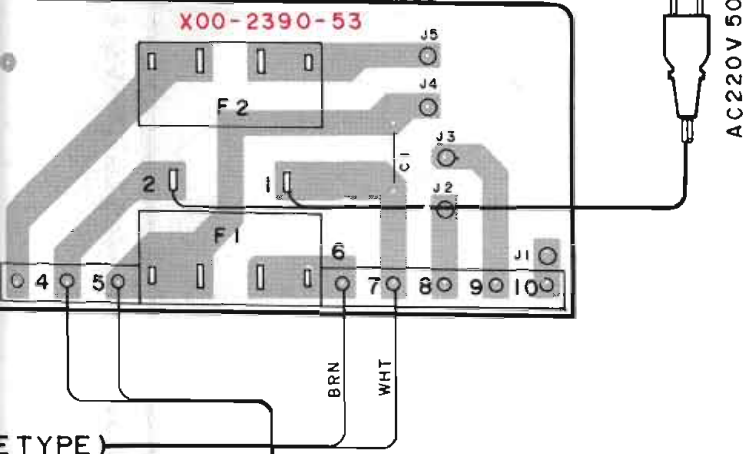

(E TYPE)

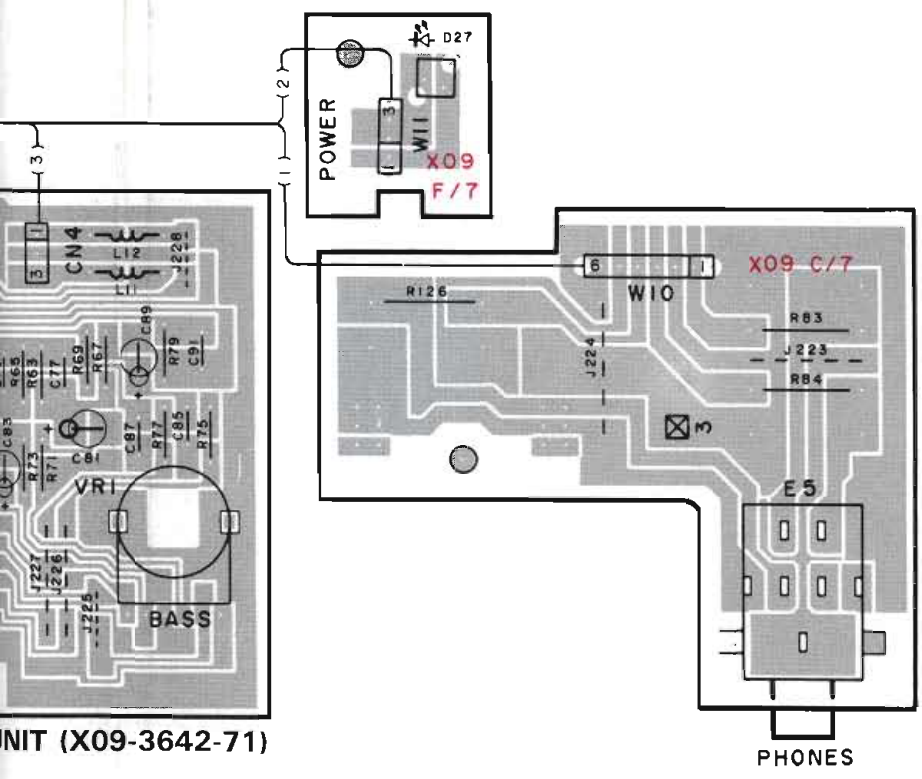
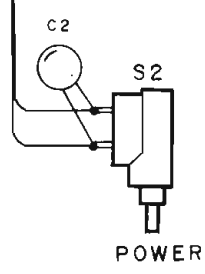

UNIT (X09-3642-71)

KA-550D (E)

Refer to the schermatic diagram for the values of resistors and capacitors.

(X09-364X-XX) (A/7)

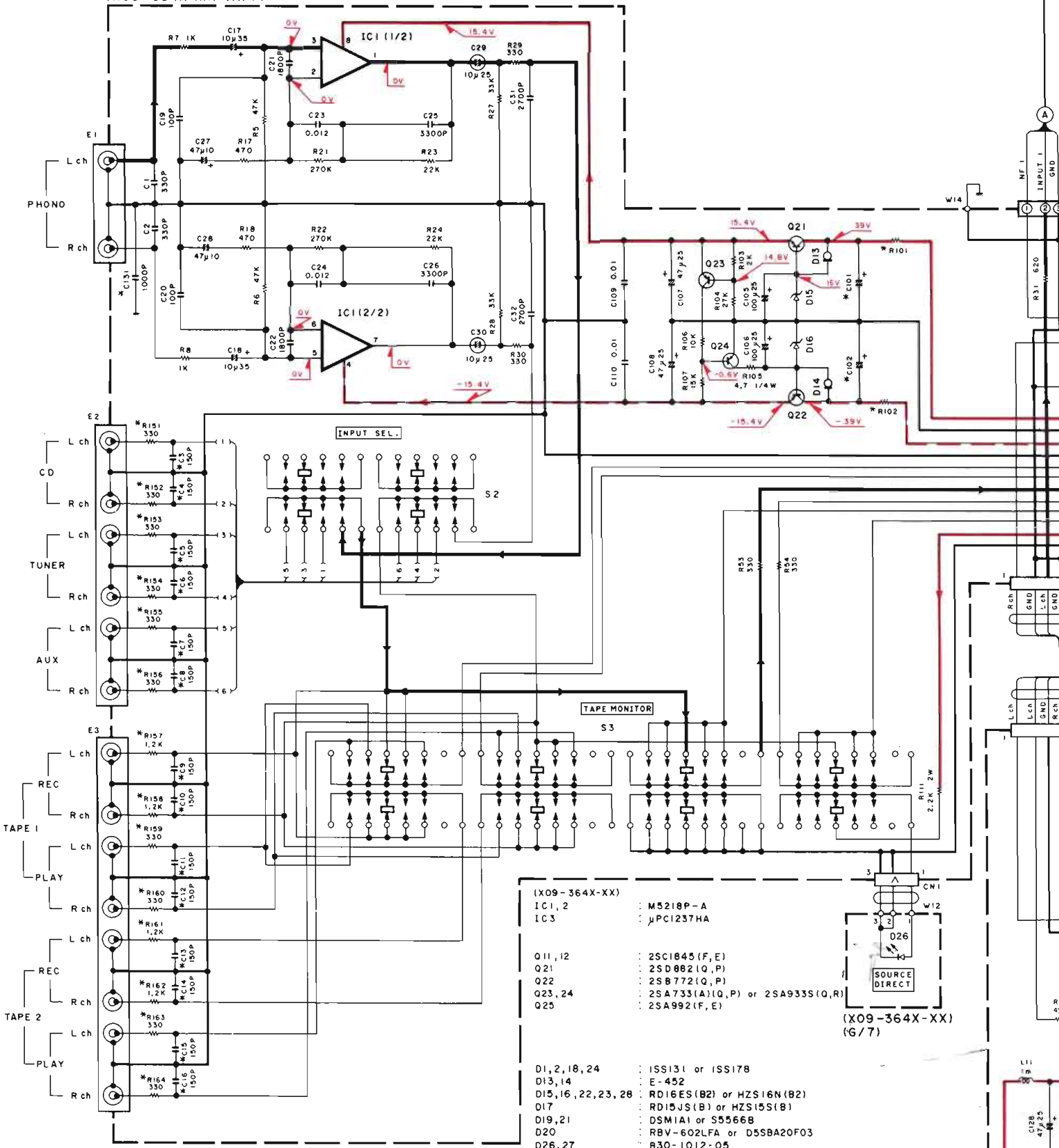

(X09-364X-XX)
 IC1, 2 : M5218P-A
 IC3 : μ PC1237HA

Q11, 12 : 2SC1845 (F, E)
 Q21 : 2SD882 (Q, P)
 Q22 : 2SB772 (Q, P)
 Q23, 24 : 2SA733(A) (Q, P) or 2SA933S (Q, R)
 Q25 : 2SA992 (F, E)

D1, 2, 18, 24 : ISS131 or ISS178
 D13, 14 : E-452
 D15, 16, 22, 23, 28 : RD16ES (B2) or HZS16N (B2)
 D17 : RD15J (B) or HZS15S (B)
 D19, 21 : DSM1A1 or S5566B
 D20 : RBV-602LFA or D5SBA20F03
 D26, 27 : B30-1012-05

(X09-364X-XX)
 (G/7)

7

2SA733 (A)
 2SA992
 2SC1845
 2SC945 (A)

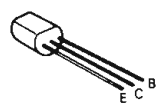

2SA1110
 2SB772
 2SC2590
 2SD882

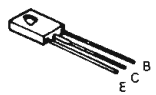

2SA1489

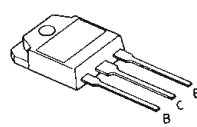

2SC3853

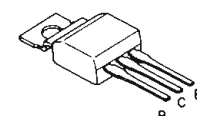

2SA933S

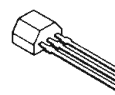

Q101, 102 : 2SC3853
Q103, 104 : 2SA1489
Q105, 106 : 2SC4137

(X09-364X-XX) (D/7)

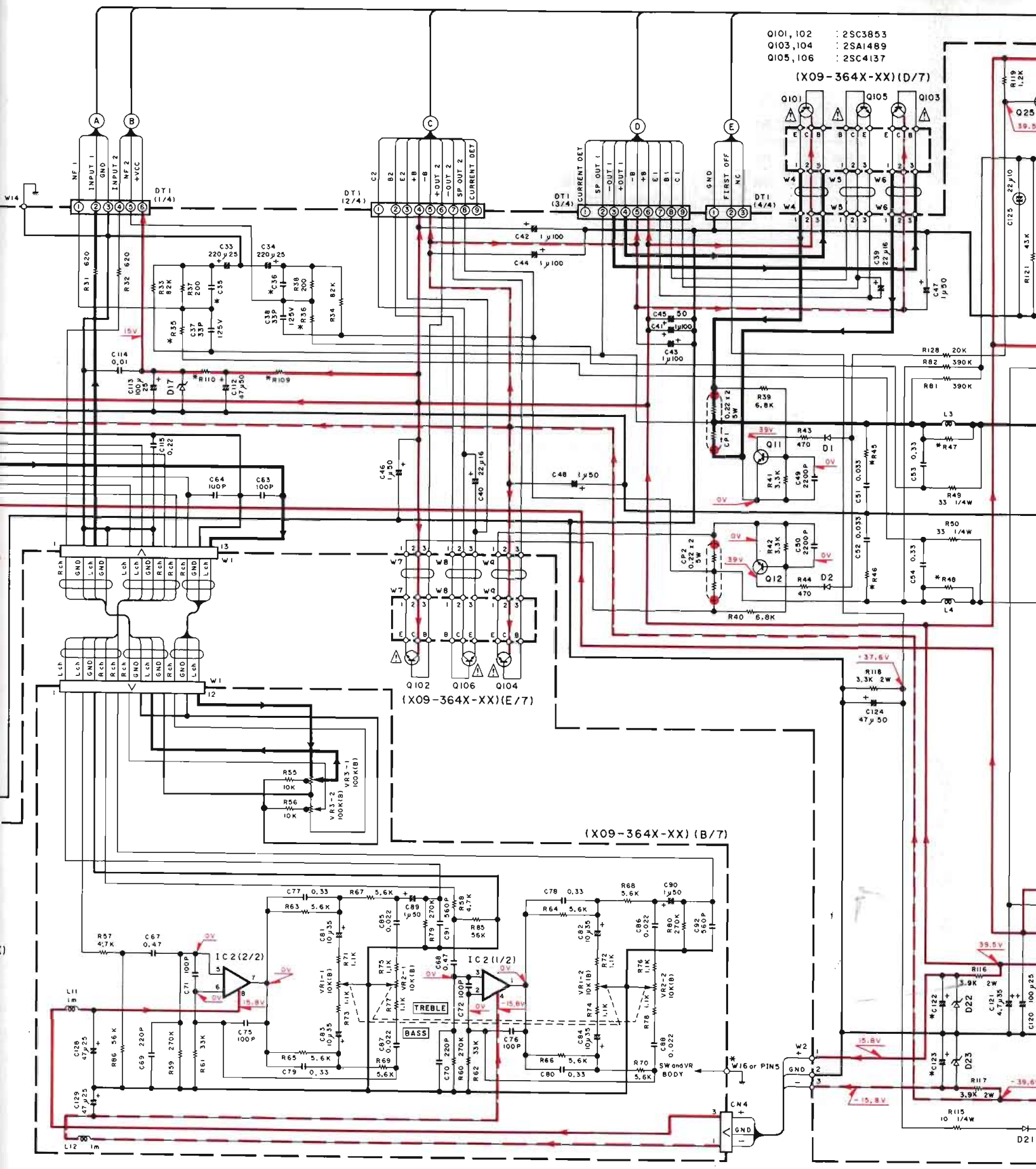

(X09-364X-XX) (E/7)

(X09-364X-XX) (B/7)

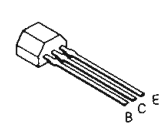

2SC4137



M5218P-A

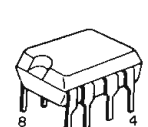

μPC1237HA

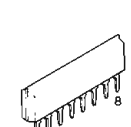

(X89-1010-06) JAPAN MADE
(X07-2362-74) SINGAPORE MADE

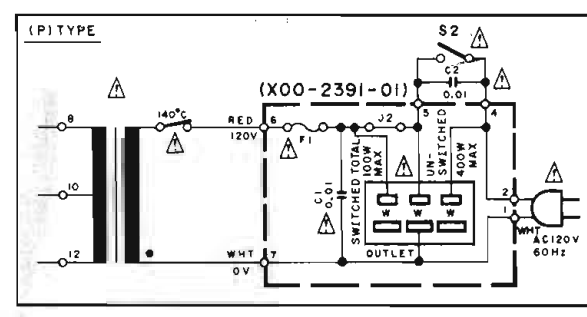
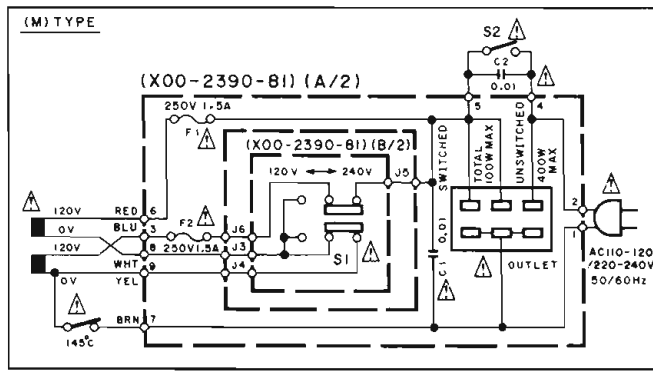
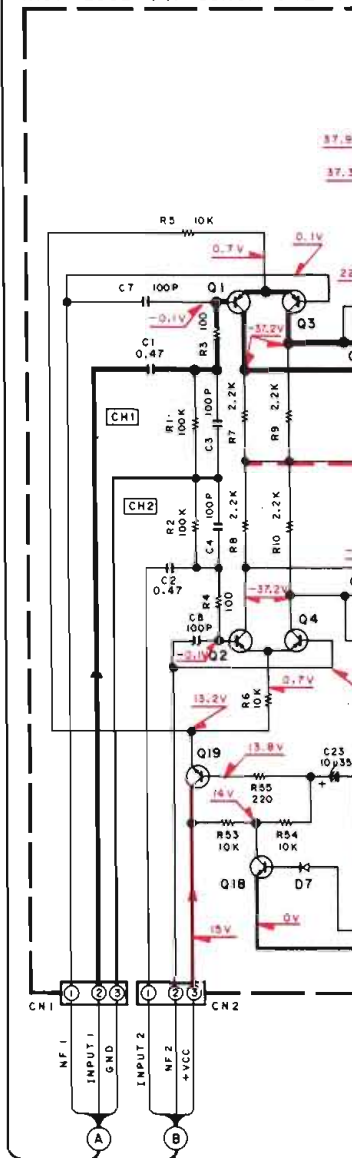
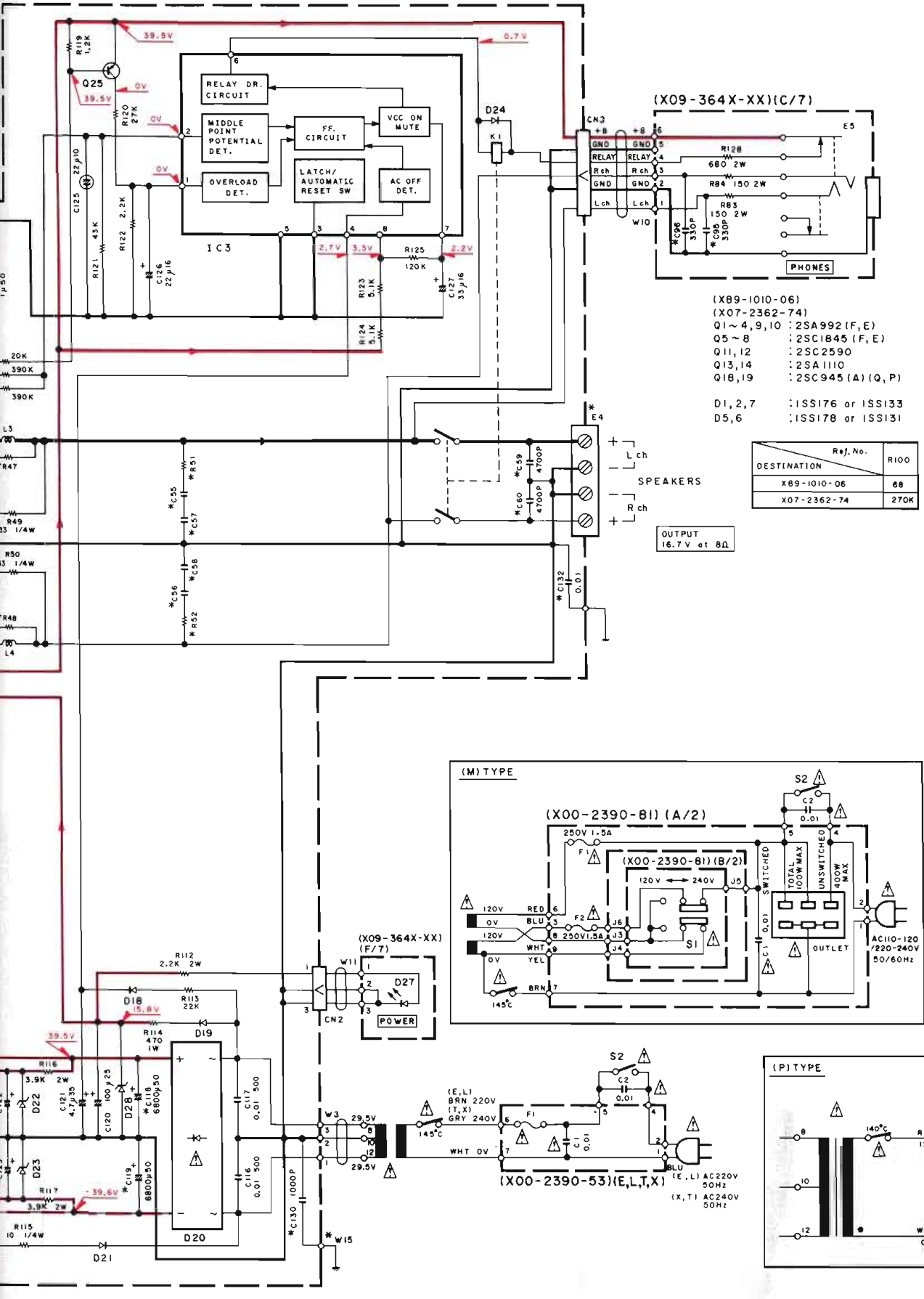

DC voltages are as measured with a high impedance voltmeter with no signal input. Values may vary slightly due to variations between individual instruments or/and units.

Les tensions c.c. doivent être mesurées avec un voltmètre à haute impédance sans signal d'entrée. Les valeurs peuvent différer légèrement du fait des variations inhérentes aux appareils et aux instruments de mesure individuels.

Die an einem signal aufgrun Instrument

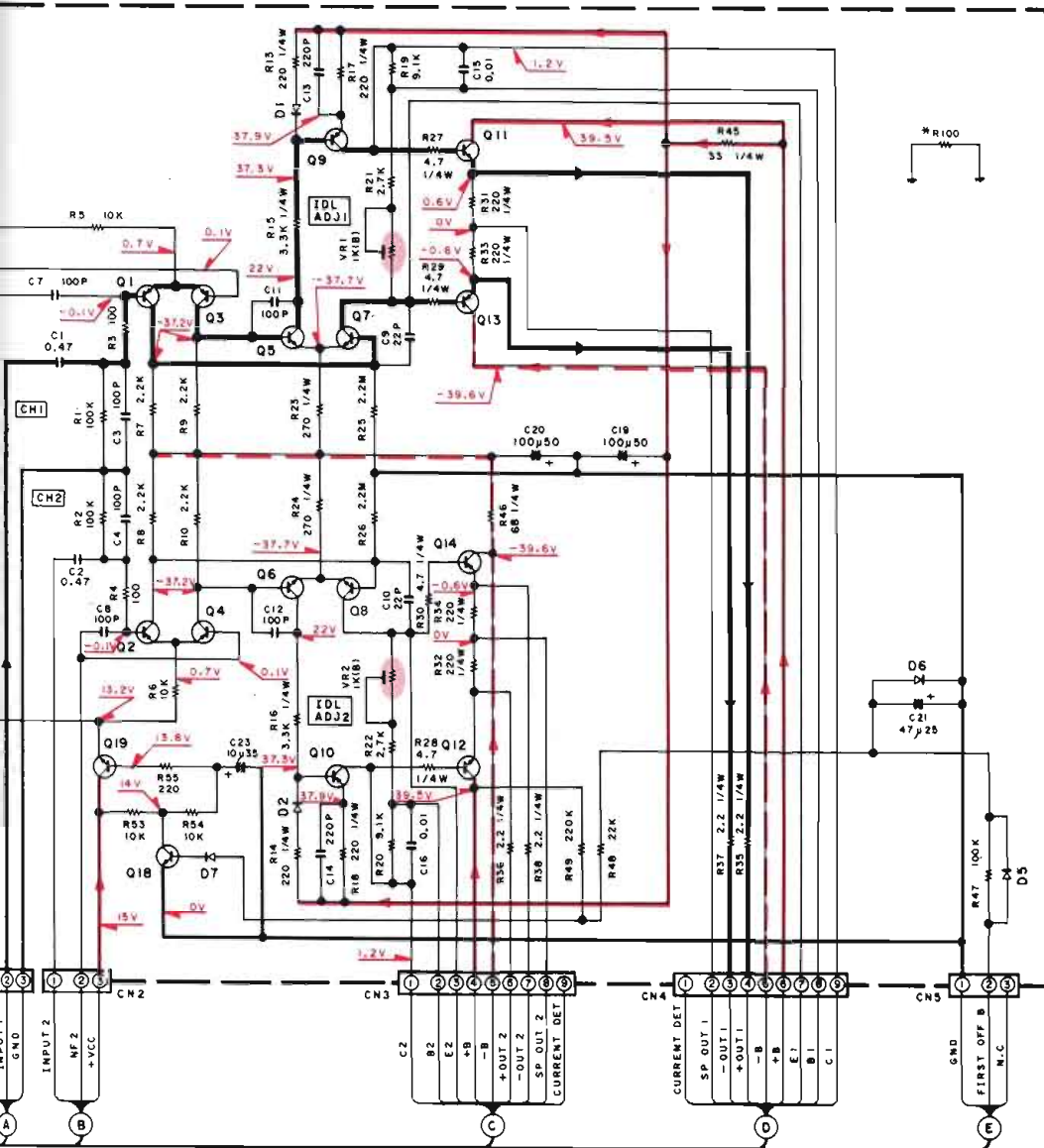

X-XXI

POSITION	Ref. No.	R35,36	R45,46,51,52	R47,48	R101,102	R104,110	R151~156,159 160,163,164	R157,158 161,162	C3~16	C35,36	C55~58
2-73	E	22K 1/4W	4.7 2W	10 1/4W	1 1W	1.8K 2W	330	1.2K	150P	220P	0.068
1-74	L, M, X, P	22K 1/6W	10 2W	4.7 1/4W	220 1/4W	1.8K 1/4W	NO	NO	NO	100P	0.1
0-54	T	22K 1/6W	10 2W	4.7 1/4W	220 1/4W	1.8K 1/4W	NO	NO	NO	100P	0.1

SINGAPORE MADE

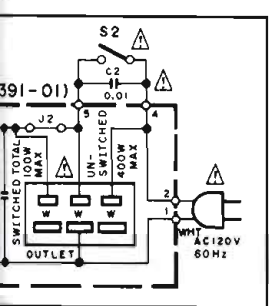

C59,60	C95,96	C101,102	C118,119	C122,123	C130,131	C132	W15	W16	5PIN	E4
4700P	330P	220µ50	C90-1662-05	470µ25	1000P	0.01	YES	NO	YES	E20-0474-05
NO	NO	100µ50	C90-1663-05	4.7µ35	NO	NO	NO	YES	NO	E20-0473-05
NO	NO	100µ50	C90-1663-05	4.7µ35	NO	NO	NO	YES	NO	E20-0474-05



KA-550D(E)

CAUTION: For continued safety, replace safety critical components only with manufacturer's recommended parts (refer to parts list). Indicates safety critical components. To reduce the risk of electric shock, leakage-current or resistance measurements shall be carried out (exposed parts are acceptably insulated from the supply circuit) before the appliance is returned to the customer.

avec un volt-d'entrée. Les fait des varia-instruments de

Die angegebenen Gleichspannungswerte wurden mit einem hochohmigen Spannungsmesser ohne Eingangssignal gemessen. Dabei schwanden die Meßwerte aufgrund von Unterschieden zwischen einzelnen Instrumenten oder Geräten u.U. geringfügig.

KA-550D

KENWOOD

EXPLODED VIEW

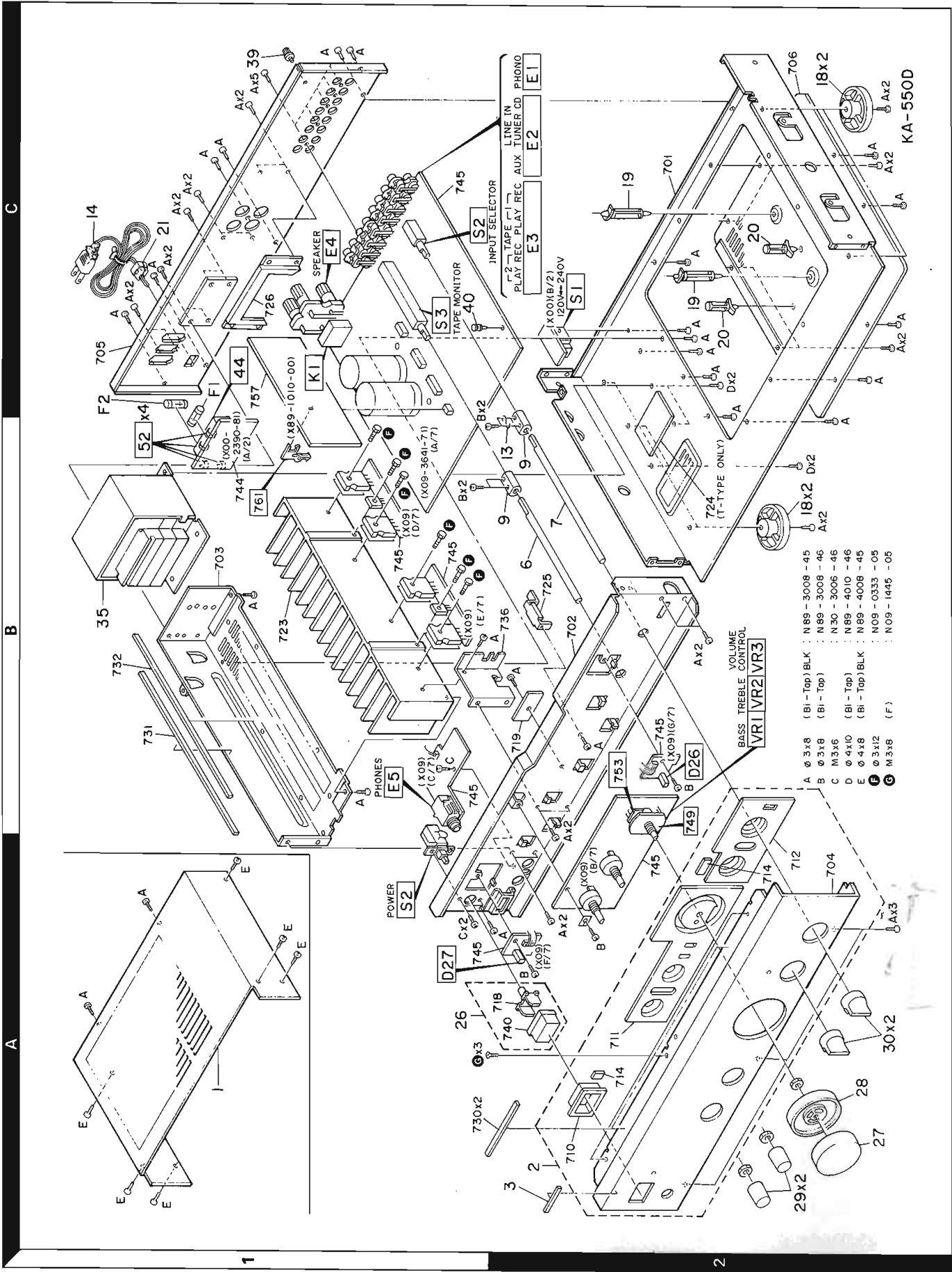

- | | | | |
|---|--------|-------------|------------------|
| A | ∅ 3x8 | (BI-Top)BLK | N 89 - 3008 - 45 |
| B | ∅ 3x8 | (BI-Top) | N 89 - 3008 - 46 |
| C | M3x6 | | N 30 - 3006 - 45 |
| D | ∅ 4x10 | (BI-Top) | N 89 - 4010 - 46 |
| E | ∅ 4x8 | (BI-Top)BLK | N 89 - 4008 - 45 |
| F | ∅ 3x12 | | N 09 - 0333 - 05 |
| G | M3x8 | (F) | N 09 - 1445 - 05 |

Parts with the exploded numbers larger than 700 are not supplied.

PARTS LIST

× New Parts

Parts without Parts No. are not supplied.

Les articles non mentionnés dans le Parts No. ne sont pas fournis.

Telle ohne Parts No. werden nicht geliefert.

Ref. No. 参照番号	Address 位置	New Parts 新	Parts No. 部品番号	Description 部品名 / 規格	Desti- nation 仕 向	Re- marks 備考
KA-550D						
1	1A	*	A01-1658-01	METALLIC CABINET		
2	2A	*	A20-5546-02	PANEL ASSY		
3	2A		B43-0278-04	KENWOOD BADGE		
-			B46-0076-13	WARRANTY CARD	X	
-			B46-0121-03	WARRANTY CARD	P	
-			B46-0122-13	WARRANTY CARD	EL	
-			B46-0143-03	WARRANTY CARD	T	
-		*	B50-8950-00	INSTRUCTION MANUAL(ENGLISH)		
-		*	B50-8951-00	INSTRUCTION MANUAL(FRENCH)	ELMXP	
-		*	B50-8952-00	INSTRUCTION MANUAL(G,D,I)	EL	
-		*	B50-8953-00	INSTRUCTION MANUAL(SPANISH)	M	
-			B58-0803-13	CAUTION CARD	E	
△ C2			C91-0023-05	CERAMIC 0.01UF AC250V	M	
△ C2			C91-0647-05	CERAMIC 0.01UF P	ELXTP	
6	2B		D21-1445-04	EXTENSION SHAFT(S-DIRECT)		
7	2B		D21-1446-04	EXTENSION SHAFT(TAPE SEL)		
9	2B,2C		D22-0063-04	SHAFT COUPLING (TAPE SEL)		
13	2B,2C	*	E29-0320-04	LEAD PLATE		
△ 14	1C		E30-0459-05	AC POWER CORD	EL	
△ 14	1C		E30-0812-05	AC POWER CORD	M	
△ 14	1C		E30-0974-05	AC POWER CORD	P	
△ 14	1C		E30-1341-05	AC POWER CORD	X	
△ 14	1C		E30-1416-05	AC POWER CORD	T	
△ F1	1C		F05-1623-05	FUSE (SEMKO) (250V T1.6A)	ELXT	
△ F1	1C		F06-3023-05	FUSE (UL) (250V 3A)	P	
△ F1 ,2	1C		F05-1521-05	FUSE (250V 1.5A)	M	
-		*	H01-7880-04	ITEM CARTON CASE		
-		*	H10-3625-12	POLYSTYRENE FOAMED FIXTURE		
-		*	H10-3626-12	POLYSTYRENE FOAMED FIXTURE		
-			H25-0225-04	PROTECTION BAG (850X450XD.03)		
-			H25-0232-04	PROTECTION BAG (235X350XD.03)		
18	2B,2C		J02-0378-05	FOOT		
19	2C		J19-0515-05	UNIT HOLDER (H-14.6)		
20	2C		J19-2536-05	UNIT HOLDER		
△ 21	1C		J42-0083-05	POWER CORD BUSHING		
-			J61-0307-05	WIRE BAND		
26	1A		K29-3212-04	KNOB ASSY(BUTTON) POWER		
27	2A	*	K29-3213-04	KNOB (VOLUME)		
28	2A		K29-3214-04	KNOB (VOLUME)		
29	2A	*	K29-3215-04	KNOB (BASS,TREBLE)		
30	2A	*	K29-3216-04	KNOB (TAPE MONI,INPUT SEL)		
△ 35	1B	*	L01-5291-05	POWER TRANSFORMER	P	
△ 35	1B	*	L01-5292-15	POWER TRANSFORMER	EL	
△ 35	1B	*	L01-5295-05	POWER TRANSFORMER	M	
△ 35	1B	*	L01-5297-15	POWER TRANSFORMER	XT	
39	1C		N08-0128-35	BINDING POST (GND)		
40	1C	*	N29-0255-05	PUSH RIVET		
F	1B		N09-0333-05	TAPPING SCREW (3X12) TR		
G	2A		N09-1445-05	SET SCREW (M3X8) PANEL		
△ S2	1A		S40-1066-05	PUSH SWITCH (POWER TYPE)		

E: Europe

K: USA

P: Canada

U: PX(Far East, Hawaii)

T: England

M: Other Areas

UE: AAFES(Europe)

X: Australia

L: Scandinavia

△ indicates safety critical components.

PARTS LIST

× New Parts

Parts without Parts No. are not supplied.

Les articles non mentionnes dans le Parts No. ne sont pas fournis.

Teile ohne Parts No. werden nicht geliefert.

Ref. No. 参照番号	Address 位置	New Parts 新	Parts No. 部品番号	Description 部品名 / 規格	Desti- nation 仕 向	Re- marks 備考
△ Q101,102			2SC3853	TRANSISTOR		
△ Q103,104			2SA1489	TRANSISTOR		
△ Q105,106		*	2SC4137	TRANSISTOR		
POWER SUPPLY UNIT (X00-2390-53)						
△ C1			C91-0023-05	CERAMIC 0.01UF AC250V	M	
△ C1			C91-0647-05	CERAMIC 0.01UF P	ELXTP	
△ 44	1C	*	E03-0077-05	AC OUTLET	M	
△ 44	1C	*	E03-0078-05	AC OUTLET	P	
52	1B		J13-0041-05	FUSE CLIP (Ø6)	MP	
52	1B		J13-0054-05	FUSE CLIP (Ø5)	ELXT	
△ S2	2C		S31-2126-05	SLIDE SWITCH (POWER TYPE)	M	
AUDIO UNIT (X09-3642-71)						
D26 ,27	1A,2B		B30-1012-05	LED(SLP-981C-50)SOURCE DIR ,P0W		
C1 ,2			CF92FV1H331K	MF 330PF K		
C3			CF92FV1H151K	MF 150PF K	E	
C4		*	CF92FV1H151K	MF 150PF K	E	
C5			CF92FV1H151K	MF 150PF K	E	
C6		*	CF92FV1H151K	MF 150PF K	E	
C7			CF92FV1H151K	MF 150PF K	E	
C8 ,9		*	CF92FV1H151K	MF 150PF K	E	
C10			CF92FV1H151K	MF 150PF K	E	
C11		*	CF92FV1H151K	MF 150PF K	E	
C12 ,13			CF92FV1H151K	MF 150PF K	E	
C14		*	CF92FV1H151K	MF 150PF K	E	
C15			CF92FV1H151K	MF 150PF K	E	
C16		*	CF92FV1H151K	MF 150PF K	E	
C17 ,18			CE04KW1V100M	ELECTRO 10UF 35WV		
C19 ,20			CC45FSL1H101J	CERAMIC 100PF J		
C21 ,22			CF92FV1H182J	MF 1800PF J		
C23 ,24			CF92FV1H123J	MF 0.012UF J		
C25 ,26			CF92FV1H332J	MF 3300PF J		
C27 ,28			CE04KW1A470M	ELECTRO 47UF 10WV		
C29 ,30			C90-1332-05	NP-ELEC 10UF 25WV		
C31 ,32			CF92FV1H272J	MF 2700PF J		
C33 ,34			CE04KW1E221M	ELECTRO 220UF 25WV		
C35 ,36			CQ09FS1H101J	POLYSTY 100PF J	LMXTP	
C35 ,36			CQ09FS1H221J	POLYSTY 220PF J	E	
C37 ,38			C91-0172-05	POLYSTY 33PF K		
C39 ,40			CE04KW1C220M	ELECTRO 22UF 16WV		
C41 -48			CE04KW1H010M	ELECTRO 1.0UF 50WV		
C49 ,50			CK45FB1H222K	CERAMIC 2200PF K		
C51 ,52			CF92FV1H333J	MF 0.033UF J		
C53 ,54			CF92FV1H334J	MF 0.33UF J		
C55 -58			CF92FV1H104J	MF 0.10UF J	LMXTP	
C55 -58			CF92FV1H683J	MF 0.068UF J	E	
C59 ,60			CK45FF1H472Z	CERAMIC 4700PF Z	E	
C63 ,64			CC45FSL1H101J	CERAMIC 100PF J		
C67 ,68			CF92FV1H474J	MF 0.47UF J		
C69 ,70			CQ09FS1H221J	POLYSTY 220PF J		
C71 ,72			CF92FV1H101K	MF 100PF K		
C75 ,76			CQ09FS1H101J	POLYSTY 100PF J		
C77 -80			CF92FV1H334J	MF 0.33UF J		

E: Europe K: USA P: Canada
 U: PX(Far East, Hawaii) T: England M: Other Areas
 UE: AAFES(Europe) X: Australia L: Scandinavia

△ indicates safety critical components.

PARTS LIST

× New Parts

Parts without Parts No. are not supplied.

Les articles non mentionnés dans le Parts No. ne sont pas fournis.

Teile ohne Parts No. werden nicht geliefert.

Ref. No. 参照番号	Address 位置	New Parts 新	Parts No. 部品番号	Description 部品名 / 規格	Desti- nation 仕 向	Re- marks 備考
C81 ,82 C83 ,84 C85 -88 C89 ,90 C91 ,92			CE04KW1V100M CE04KW1V100M CF92FV1H223J CE04KW1H010M CK45FB1H561K	ELECTRO 10UF 35WV ELECTRO 10UF 35WV MF 0.022UF J ELECTRO 1.0UF 50WV CERAMIC 560PF K		
C95 ,96 C101,102 C101,102 C105,106 C107,108			CC45FSL1H331J CE04KW1H101M CE04KW1H221M CE04KW1E101M CE04KW1E470M	CERAMIC 330PF J ELECTRO 100UF 50WV ELECTRO 220UF 50WV ELECTRO 100UF 25WV ELECTRO 47UF 25WV	E LMXTP E	
C109,110 C112 C113 C114 C115			CF92FV1H103J CE04KW1H470M CE04KW1E101M CF92FV1H103J CF92FV1H224J	MF 0.010UF J ELECTRO 47UF 50WV ELECTRO 100UF 25WV MF 0.010UF J MF 0.22UF J		
C116,117 C118,119 C118,119 C120 C121			CK45FE2H103P C90-1662-05 C90-1663-05 CE04KW1E101M CE04KW1V4R7M	CERAMIC 0.010UF P ELECTRO 6800UF 50WV ELECTRO 6800UF 50WV ELECTRO 100UF 25WV ELECTRO 4.7UF 35WV	E LMXTP E	
C121-123 C122,123 C124 C125 C126			CE04KW1V4R7M CE04KW1E471M CE04KW1H470M C90-1333-05 CE04KW1C220M	ELECTRO 4.7UF 35WV ELECTRO 470UF 25WV ELECTRO 47UF 50WV NP-ELEC 22UF 10WV ELECTRO 22UF 16WV	LMXTP E	
C127 C128,129 C130,131 C132			CE04KW1C330M CE04KW1E470M CF92FV1H102J CF92V1H103J	ELECTRO 33UF 16WV ELECTRO 47UF 25WV MF 1000PF J MF 0.010UF J	E E	
E1 E2 E3 E4 E4	1C,2C 1C,2C 1C,2C 1C 1C	*	E13-0235-05 E13-0621-05 E13-0814-05 E20-0473-05 E20-0474-05	PHONE JACK (2P) PHONE PHONE JACK (6P) LINE IN PHONE JACK (8P) TAPE SCREW TERMINAL BOARD(SPEAKERS) SCREW TERMINAL BOARD(SPEAKERS)	LMXP ET	
E5	1B		E11-0160-05	PHONE JACK (7P) PHONES		
L3 ,4 L11 ,12			L39-0080-15 L40-1021-14	PHASE-COMPENSATION COIL SMALL FIXED INDUCTOR(1.0MH,K)		
CP1 ,2 R45 ,46 R45 ,46 R47 ,48 R47 ,48			R90-0187-05 RS14DB3D100JTE RS14DB3D4R7JTE RD14AB2E100JTS RD14AB2E4R7JTS	MULTI-COMP 0.22X2 K 5W FL-PROOF RS 10 J 2W FL-PROOF RS 4.7 J 2W FL-PROOF RD 10 J 1/4W FL-PROOF RD 4.7 J 1/4W	LMXTP E E LMXTP	
R49 ,50 R51 ,52 R51 ,52 R83 ,84 R101,102		*	RD14AB2E330JTS RS14DB3D100JTE RS14DB3D4R7JTE RS14DB3D151JTE RD14AB2E221JTS	FL-PROOF RD 33 J 1/4W FL-PROOF RS 10 J 2W FL-PROOF RS 4.7 J 2W FL-PROOF RS 150 J 2W FL-PROOF RD 220 J 1/4W	LMXTP E LMXTP	
R101,102 R105 R109,110 R109,110 R111,112		*	RS14DB3A1R0JTE RD14AB2E4R7JTS RD14AB2E182JTS RS14DB3D182JTE RS14DB3D222JTE	FL-PROOF RS 1.0 J 1W FL-PROOF RD 4.7 J 1/4W FL-PROOF RD 1.8K J 1/4W FL-PROOF RS 1.8K J 2W FL-PROOF RS 2.2K J 2W	E LMXTP E	
R114		*	RS14KB3A391JTE	FL-PROOF RS 390 J 1W		

E: Europe K: USA P: Canada
 U: PX(Far East, Hawaii) T: England M: Other Areas
 UE: AAFES(Europe) X: Australia L: Scandinavia

▲ indicates safety critical components.

PARTS LIST

× New Parts

Parts without Parts No. are not supplied.

Les articles non mentionnés dans le Parts No. ne sont pas fournis.

Telle ohne Parts No. werden nicht geliefert.

Ref. No. 参照番号	Address 位置	New Parts 新	Parts No. 部品番号	Description 部品名 / 規格	Desti- nation 仕向	Re- marks 備考
R115			RD14AB2E100JTS	FL-PROOF RD 10 J 1/4W		
R116,117		*	RS14DB3D392JTE	FL-PROOF RS 3.9K J 2W		
R118		*	RS14DB3D332JTE	FL-PROOF RS 3.3K J 2W		
R126		*	RS14DB3D681JTE	FL-PROOF RS 680 J 2W		
VR1 ,2	2B		RD6-3048-05	POTENTIOMETER(10K B)BASS,TREBL		
VR3	2B	*	R19-5002-05	POTENTIOMETER(100K B)		
K1	1C		SS1-2078-05	MAGNETIC RELAY		
S2	1C		S29-4020-05	ROTARY SWITCH(INPUT SELECTOR)		
S3	1C	*	S29-8002-05	ROTARY SWITCH(TAPE MONITOR)		
D1 ,2			1SS131	DIODE		
D1 ,2			1SS178	DIODE		
D13 ,14			E-452	CONSTANT CURRENT DIODE		
D15 ,16			HZS16N(B2)	ZENER DIODE		
D15 ,16			RD16ES(B2)	ZENER DIODE		
D17			HZS15S(B)	ZENER DIODE		
D17			RD15JS(B)	ZENER DIODE		
D18			1SS131	DIODE		
D18			1SS178	DIODE		
D19			DSM1A1	DIODE		
D19			S5566B	DIODE		
D20		*	D55BA20F03	DIODE		
D20			RBV-602LFA	DIODE		
D21			DSM1A1	DIODE		
D21			S5566B	DIODE		
D22 ,23			HZS16N(B2)	ZENER DIODE		
D22 ,23			RD16ES(B2)	ZENER DIODE		
D24			1SS131	DIODE		
D24			1SS178	DIODE		
D28			HZS16N(B2)	ZENER DIODE		
D28			RD16ES(B2)	ZENER DIODE		
IC1 ,2			M5218P-A	IC(OP AMP X2)		
IC3			UPC1237HA	IC(POWER AMP)		
Q11 ,12			2SC1845(F,E)	TRANSISTOR		
Q21			2SD882(Q,P)	TRANSISTOR		
Q22			2SB772(Q,P)	TRANSISTOR		
Q23 ,24			2SA733(A)(Q,P)	TRANSISTOR		
Q23 ,24			2SA933S(Q,R)	TRANSISTOR		
Q25			2SA992(F,E)	TRANSISTOR		
MAIN AMPLIFIER UNIT (X89-1010-06: JAPAN MADE, X07-2362-74: SINGAPORE MADE)						
C1 ,2			CF92FV1H474J	MF 0.47UF J		
C3 ,4			CQ09FS1H101J	POLYSTY 100PF J		
C7 ,8			CQ09FS1H101J	POLYSTY 100PF J		
C9 ,10			CC45FSL1H220J	CERAMIC 22PF J		
C11 ,12			CC45FSL1H101J	CERAMIC 100PF J		
C13 ,14			CC45FSL1H221J	CERAMIC 220PF J		
C15 ,16			CK45FF1H103Z	CERAMIC 0.010UF Z		
C19			CE04KW1H101M	ELECTRO 100UF 50WV		
C20			CE04KW1H101M	ELECTRO 100UF 50WV		
C21			CE04KW1E470M	ELECTRO 47UF 25WV		
C23			CE04KW1V100M	ELECTRO 10UF 35WV		
R13 ,14			RD14AB2E221JTS	FL-PROOF RD 220 J 1/4W		
R17 ,18			RD14AB2E221JTS	FL-PROOF RD 220 J 1/4W		
R23 ,24			RD14AB2E271JTS	FL-PROOF RD 270 J 1/4W		

E: Europe

K: USA

P: Canada

U: PX(Far East, Hawaii)

T: England

M: Other Areas

UE: AAFES(Europe)

X: Australia

L: Scandinavia

△ indicates safety critical components.

PARTS LIST

× New Parts

Parts without Parts No. are not supplied.

Les articles non mentionnés dans le Parts No. ne sont pas fournis.

Telle ohne Parts No. werden nicht geliefert.

Ref. No. 参照番号	Address 位置	New Parts 新	Parts No. 部品番号	Description 部品名 / 規格	Desti- nation 仕向	Re- marks 備考
R27 -30			RD14AB2E4R7JTS	FL-PROOF RD 4.7 J 1/4W		
R31 -34			RD14AB2E221JTS	FL-PROOF RD 220 J 1/4W		
R35 -38			RD14AB2E2R2JTS	FL-PROOF RD 2.2 J 1/4W		
R45			RD14AB2E330JTS	FL-PROOF RD 33 J 1/4W		
R46			RD14AB2E680JTS	FL-PROOF RD 68 J 1/4W		
VR1 ,2			R12-1070-05	TRIMMING POT. (1K B) IDLE ADJ		
D1 ,2			1SS133	DIODE		
D1 ,2			1SS176	DIODE		
D5 ,6			1SS131	DIODE		
D5 ,6			1SS178	DIODE		
D7			1SS133	DIODE		
D7			1SS176	DIODE		
Q1 -4			2SA992(F,E)	TRANSISTOR		
Q5 -8			2SC1845(F,E)	TRANSISTOR		
Q9 ,10			2SA992(F,E)	TRANSISTOR		
Q11 ,12			2SC2590	TRANSISTOR		
Q13 ,14			2SA1110	TRANSISTOR		
Q18 ,19			2SC945(A)(Q,P)	TRANSISTOR		

E: Europe

K: USA

P: Canada

U: PX(Far East, Hawaii)

T: England

M: Other Areas

UE: AAFES(Europe)

X: Australia

L: Scandinavia

 indicates safety critical components.

SPECIFICATIONS

Power Output

35 watts per channel minimum RMS, both channels driven at 8 ohms from 20 Hz to 20,000 Hz with no more than 0.08% total harmonic distortion

Maximum continuous Power Output (DIN) 1 kHz at 4 ohms	52 W + 52 W
Maximum continuous Power Output (DIN) 1 kHz at 8 ohms	41 W + 41 W
Maximum continuous Power Output (IEC/NF) from 63 Hz to 12,500 Hz 0.7%	
Total Harmonic Distortion at 8 ohms	40 W + 40 W
Total Harmonic Distortion	
(20 Hz-20,000 Hz, 8 ohms)	: 0.08%
(1 kHz, 8 ohms)	: 0.009%
Intermodulation Distortion	: 0.03% at rated power (60 Hz: 7 kHz = 4:1)
Frequency Response	: 10 Hz to 80 kHz/ +0 dB, -3 dB (IHF'66)
Phono Frequency Response	: RIAA Standard curve ± 0.4 dB (30 Hz to 20 kHz)
Damping Factor	: 250 (50 Hz input 8 ohms)
Signal to Noise Ratio	IHF'66
PHONO (MM)	: 72 dB, 2.5 mV
TUNER/CD/AUX	: 106 dB, 150 mV
TAPE	: 97 dB, 150 mV
	IHF-A
	: 76 dB
	: 82 dB
	: 82 dB
Signal to Noise Ratio at Unweighted, 50 mW Output (DIN)	
PHONO (MM)	: 57 dB
TUNER/CD/AUX/TAPE	: 57 dB
Input Sensitivity/Impedance	
PHONO (MM)	: 2.5 mV/ 47 kohms
TUNER/CD/AUX/TAPE	: 150 mV/ 47 kohms
Phono Maximum Input Level (MM)	: 150 mV, 0.08% T.H.D. at 1 kHz
Output Level/Impedance	
TAPE REC	: 150 mV/220 ohms
REC OUT	: 150 mV/220 ohms
Channel Separation (DIN) at 1,000 Hz	
PHONO (Terminated with 2.2 kohms)	: 64 dB
AUX (Terminated with 47 kohms + 250 pF)	: 58 dB
Tone Control	
TREBLE	: ± 10 dB at 10 kHz
BASS	: ± 10 dB at 100 Hz
Phono Input Capacity	: 320 pF
General	
Power Requirements	: 120 V, 60 Hz..... Canada Models
	: 220 V, 50 Hz..... European Models
	: 240 V, 50 Hz..... UK and Australia Models
	: 110-120/220-240 V 50/60 Hz switchable.....Others
Power Consumption	: 2.5 A (Canada Models)
	: 150 W (Others)
Dimensions	: W 440 mm (17-5/16")
	: H 103 mm (4-1/16")
	: D 345 mm (13-9/16")
Weight (Net)	: 6.8 kg (15.0 lb)

Kenwood follows a policy of continuous advancements in development. For this reason specifications may be changed without notice.

Kenwood poursuit une politique de progrès constants en ce qui concerne le développement. Pour cette raison, les spécifications sont sujettes à modifications sans préavis.

Kenwood strebt ständige, Verbesserungen in der Entwicklung an. Daher bleiben Änderungen der technischen Daten jederzeit vorbehalten.

Note:

Component and circuitry are subject to modification to insure best operation under differing local conditions. This manual is based on, the Europe (E) standard, and provides information on regional circuit modification through use of alternate schematic diagrams, and information on regional component variations through use of parts list.

KENWOOD CORPORATION

Shionogi, Shibuya Building, 17-5, 2-chome Shibuya, Shibuya-ky, Tokyo 150, Japan

KENWOOD U.S.A. CORPORATION

2201 East Dominguez Street, Long Beach, CA 90810;
550 Clark Drive, Mount Olive, NJ 07828, U.S.A.

KENWOOD ELECTRONICS CANADA INC.

P.O. Box 1075 959 Gana Court, Mississauga, Ontario, Canada L4T 4C2

KENWOOD ELECTRONICS BENELUX N.V.

Mechelsesteenweg 418 B-1930 Zaventem, Belgium

KENWOOD ELECTRONICS DEUTSCHLAND GMBH

Rembrucker-Str. 15, 6056 Heusenstamm, West Germany

TRIO-KENWOOD FRANCE S.A.

Hi-Fi-VIDEO-CAR Hi-Fi

13, Boulevard Ney, 75018 Paris, France

TRIO-KENWOOD U.K. LTD.

17 Bristol Road, The Metropolitan Centre, Greenford, Middx UB6 8UP England

KENWOOD ELECTRONICS AUSTRALIA PTY. LTD.

4E Woodcock Place, Lane Cove, N.S.W. 2066, Australia

KENWOOD & LEE ELECTRONICS, LTD.

Wang Kee Building, 4th Floor, 34-37, Connaught Road, Central, Hong Kong